

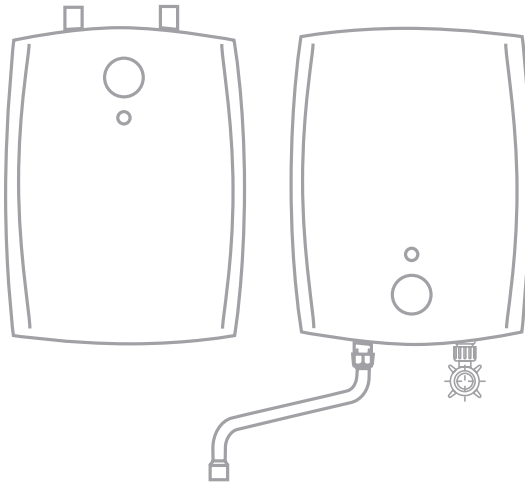

INSTRUCTION MANUAL

DXO5LV / DXU5LV
Delux vented water heaters



Illustration

DXO5LV Over Sink

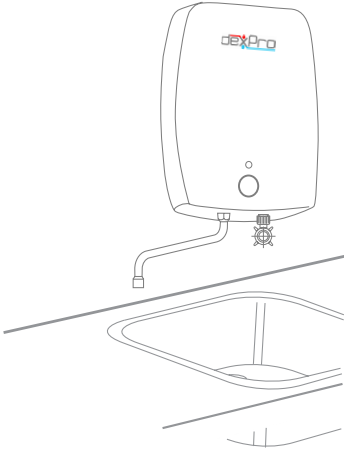

DXU5LV Under Sink

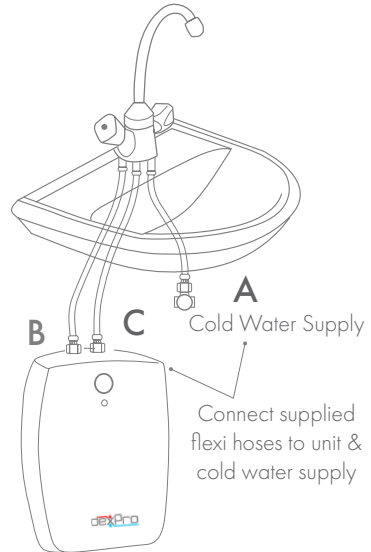

Introduction





Thank you for selecting our 5-litre Delux Vented water heater.

These instructions contain important information about commissioning, operating the device and maintenance. To ensure your safety and that of others we suggest that you read these installation and operating instructions before using the device for the first time. Please keep the instructions and other documentation close to the device.

This device has been manufactured in accordance with the prescribed standards and has been tested by the competent authorities. It has a Safety Certificate and a Certificate of Electromagnetic Compatibility. The technical data for the product is displayed on the label between the inlet and outlet pipes.

The appliance should be installed by qualified persons. All repair and maintenance work on the device, for example the removal of limestone and water scale deposits, may only be carried out by a qualified plumber/tradesperson.

These Delux Vented water heaters are ideal for use in light commercial or domestic applications where supply to a single sink is required for light hand/dish washing. Its modern design and the use of carefully selected materials and an improved manufacturing process ensure high quality.

| | |
|--|---|
|  | Complies with the basic safety standards set by European Directives |
|  | Failure to observe the instructions identified by this symbol may endanger persons. Failure to observe the instruction identified by this symbol may lead to damage to the heater. |
|  | Indicates an electrical hazard. Failure you to observe this symbol may endanger persons. Failure to observe the instruction identified by this symbol may lead to damage to the heater. |
|  | Read the manual |
|  | Faulty and/or electrical or electronic appliances that are disposed of must be handed in at the relevant recycling centres set up for this purpose. |



This appliance can be used by children aged from 8 years and above and persons with reduced physical, sensory or mental capabilities or lack of experience and knowledge if they have been given supervision or instruction concerning use of the appliance in a safe way and understand the hazards involved.



Children shall not play with the appliance. Cleaning and user maintenance shall not be made by children without supervision.

Statement of Conformity

This boiler complies with the following directives:

- 2006/95/EC Low Voltage Directive
- 2004/108/EC Electromagnetic Compatibility Directive (EMC)
- 2011/65/EC (RoHS II)
- 2009/125/EC Eco design
- (EC) No. 814/2013

The product also conforms to the following harmonised European standards:

- EN 55014-1:2006 + A1:2009 + A2:2011
- EN 55014-2:1997 + A1:2001 + A2:2008
- EN 61000-3-2:2006 + A1:2009 + A1:2009
- EN 61000-3-3:2013
- EN 62233:2008
- EN 50581:2012
- EN 60335-1:2012 + A11:2014
- EN 60335-2-21:2003 + A1:2005 + A2:2008

2. Mounting Instructions

Environment



This device is delivered in sturdy packaging in order to avoid damage during transport. This packaging consists mainly of recyclable materials. We request that you dispose of the packaging accordingly for recycling purposes.

Disposal of the appliance



Old appliances must not be disposed of in your household waste! Every consumer is legally obliged to dispose of old appliances separately from their household waste and to take them, for example, to a collection point in their local community or local district. Old electrical appliances will be accepted there free of charge. This ensures that the old appliances are properly recycled and any negative impacts on the environment are avoided. This is why electrical appliances are marked with the symbol shown on the left.

Installation

The device should be installed in accordance with the drawing on the first page of the user manual. Any other installation position may result in serious damage to the device. Installation should take place as close as possible to a cold water connection. The product should be protected from the effects of frost (for example in caravans, summer houses, etc.). **Depending on the model, the device may be installed above (DXO model) or under (DXU model) the work top.**

Frost



If there is the risk of frost in a room, the device should not be installed in this room. If, despite this advice, the device is installed in a room where there is a risk of frost, the device should be emptied before the risk arises.

Wall mounting

Select the position of the heater and install the supplied bracket. Ensure the spout will be positioned inline with the basin.

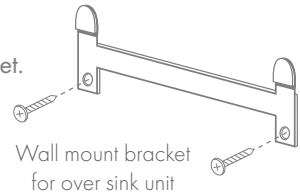

Connection to the water supply

(See illustration on page 2)

A/C = cold water inlet side (for filling) blue.

B = hot water outlet side (hot water demand) red.

The device is designed for use in non-pressure systems. This system allows water to be drawn from a single discharge point. Never use a shut-off valve in the appliance's outlet. The connection pipes must be installed as shown in the drawing. If the **incoming mains water supply pressure exceeds 5 bars**, a pressure reducing valve must be fitted in the incoming cold supply pipe.

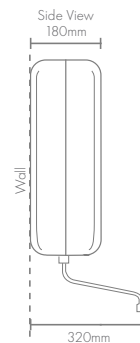
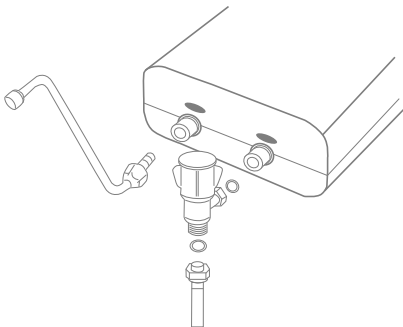

A vented tap fitting must be used for nonpressure installation. It is important you are absolutely certain that the tap you want to connect is vented. If any doubt, always consult your installer.



If a vented tap is not used, a build up of pressure could lead to significant damage and thereby void the warranty!

Connection to the electricity supply



The electrical installation must be in line with the current I.E.E. wiring regulations.



Connection should be to a 13a fused switched spur.
The appliance must be earthed.

All plumbing connections must be completed before making the electrical connections. Fill the tank with water and turn on the tap, letting the water exit out from the tank until all the air has been expelled out. You can turn the electricity on after the tank is full of water.



Ensure that the addition of this boiler will not overload the fuse protection in your mains. Internal modifications to the product may cause problems if this work is not carried out by authorized and qualified technical staff. The warranty only applies if the product has not been modified in any way, i.e. subject to it being in unchanged condition.



In order to avoid creating an unsafe situation by inappropriate resetting of the maximum temperature safety device, this unit may not be powered via an external switching device (a time switch for example) or connected to a circuit, which is regularly switched on and off by the power supply company.



Technical specifications

| 5L vented boiler | DXO5LV | DXU5LV |
|----------------------------------|---------------|---------------|
| Model | Over-sink | Under-sink |
| Wall mounting | Vertical | Vertical |
| Construction | Open | Open |
| Material | Brass | Brass |
| Distance, pipe to wall | 85mm | 85mm |
| Electric supply | 230V, 50Hz | 230V, 50Hz |
| Nominal capacity | 2,0kW | 2,0kW |
| Nominal volume | 5,3L | 5,3L |
| Total quantity of mixed water | 9,1L | 9,1L |
| Temperature range | 35 - 75 °C | 35 - 75 °C |
| Cable size | 1,0mm | 1,0mm |
| Maximum recommended water volume | 5,0L/min | 5,0L/min |
| Non-usage consumption/ day | 0,32kWh | 0,32kWh |
| Protection class | I | I |
| IP rating | IP24 | IP24 |
| Dimensions (h x w x d) | 274x185x421mm | 274x185x421mm |
| Weight when empty | 2,5kg | 2,5kg |
| Water connection | G1/2" | G3/8" |
| Operating pressure | 0MPa | 0MPa |

User Instructions



The heater must be filled with water before connection to the electrical supply.



When powering up for the first time, you must verify that the temperature indicator (light) extinguishes when the required temperature is reached. The heater only switches on again if the temperature falls below this setting. (See troubleshooting)



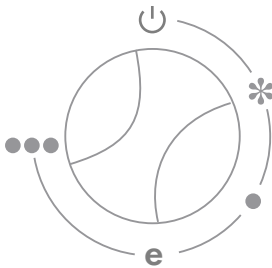

When filling for the first time, the hot water valve in the low-pressure tap fitting must be open so that water can flow into the device. If the device is not filled with water beforehand during installation, the automatic safety device will activate and switch off the appliance. (See troubleshooting instructions on how to act in the event of a fault).



Temperature setting

 Cold; heater is switched off.

 Automatic frost protection active; the device switches on if the water temperature falls below 7 °C.

 Water temperature has risen by +/- 32 °C.

 Energy-saver mode/reduced energy consumption: Greater energy savings are possible if the water temperature is set to a maximum of +/- 55 °C. This also reduces the risk of damage to the device.

 Max. temperature approx. 75 °C.

Operating the unit at a lower temperature can reduce scaling, save energy and reduce the risk of scalding.

To use the device, simply select the desired temperature setting from the listed options. Once a setting is selected the indicator light will illuminate to signal the element is heating the stored water to the desired temperature. When the light extinguishes the temperature setting has been achieved. When reducing the temperature setting of the heater, it will not take effect until the water has cooled below the new temperature set point.

Usage and Maintenance

Please refer to the previous section for details of the thermostat settings. We recommend you use position "E" as this guarantees maximum energy efficiency by maintaining the water temperature at approximately 55°C; furthermore lime scale build-up and heat loss are much lower than at higher temperatures.

Operation of the device is indicated by the indicator light, which lights up when the device is on and extinguishes when the set temperature is reached or the device is turned off.

During heating, the volume of the water in the device expands, causing a flow of water ("expansion water") from the low-pressure tap fitting. This is perfectly normal and no preventive action needs to be taken. Further tightening will not prevent the flow of expansion water. This may damage the hot water valve.

Frost

When the device has not been used for a couple of months, it must be protected against the effects of frost. Leave the power supply on and set the thermostat knob to "7". When set to this position, the device maintains the water temperature at approximately 7°C. If you will not use the device for more than half a year, unplug it, disconnect it from the water supply and empty it. To that end, hold the device with the connection hoses upwards. Remove the connection hoses. Then hold the device, with the connections pointing downwards, over a sink. Caution: the boiler will release 5 litres of water.

Maintenance



This heater does not require any maintenance by the user. Professional maintenance should always be carried out by an expert.



If faulty, never try to repair the heater yourself. Please contact the nearest service specialist or the party that supplied the appliance originally.

De-scaling

service inspection should be performed by authorized and qualified technical staff every year. De-scaling of the device during this inspection is highly recommended, especially when you live in an area with hard water exceeding 12° dH (German standard of hardness). Higher water temperature will intensify calcification. It is therefore recommended to set the device at maximum 55°C (energy-saving setting) in areas with extremely hard water >16° dH.

Cleaning

The housing of the device can simply be cleaned with a damp cloth. Do not use aggressive cleaners or cleaners with a scouring effect!

Legionella Prevention

Do not use heated water as drinking water. After prolonged shutdown of the heater for example during holidays, the heater should be fully heated up to the maximum temperature and water flushed through the tank for at least one minute.

Trouble Shooting

| | | |
|--|--|--|
| The indicator lamp does not light up | No voltage. | Check fuse and socket. |
| | Device has reached the set temperature. | No need to do anything. |
| Water temperature not as required | Thermostat set incorrectly. | Change the setting of the thermostat. |
| Too little / no water | Water pressure too low. | Check whether other cold water taps have the same problem. |
| | Stop valve not fully open. | Open the stop valve. |
| | No water. | The device should be turned off as soon as possible! Also see "The device does not operate." |
| Water lying below the device | The device is leaking. | Notify the place of purchase. |
| | Water pipes are not securely connected to the device. | Check the water connections. |
| Tap drips when heating up | Is normal due to the expansion of heated water. | No need to do anything. |
| Bubbling noises in the tank | Too much calcification. | The device must be de-scaled by an expert. |
| The leakage current circuit breaker is triggered | Too many devices on the safety group. | Remove some devices from the group or look for an empty group. |
| The device does not operate at all | If the device no longer operates, check whether the fuse or leakage current circuit-breaker has tripped. The hot water reservoir is equipped with a maximum temperature switch to ensure your safety. The device will automatically switch off if excessive heating takes place. When this happens, switch off the appliance for a few minutes by removing the plug from the power supply socket and allow the appliance to cool. The appliance can be reconnected to the mains power supply again after approx. 20 minutes. | |

Guarantee and service policy

This product is guaranteed against faulty materials and manufacture from the date of purchase for 2 years.

In the event of a faulty product firstly contact our customer services team who will guide you through the process.

Do not uninstall or return the product before contacting deXpro customer services, such action may void the warranty.

The standard warranty covers the supply of spare parts or at our sole discretion a replacement product. On-site service costs are strictly exempt from the warranty.

The guarantee specifically excludes:

- Corrosion caused by incorrect maintenance or installation of the water heater.
- Damage caused by limescale build up.
- Consequential losses, including labour charges and damages to surroundings.
- Failure to maintain and install the water heater according to the instructions in this manual.

INFORMATION FOR CORRECT DISPOSAL OF THE PRODUCT IN ACCORDANCE WITH THE EUROPEAN DIRECTIVE 2002/96/E.



At the end of its working life this equipment must not be disposed of as household waste. It must be taken to a local authority waste collection centre or to a dealer providing this service. Disposing of electrical and electronic equipment separately enables its components to be recovered and recycled to obtain significant savings in energy and resources. In order to underline the duty to dispose of this equipment separately, the product is marked with a crossed out dustbin.

